

# R82 Manatee

## CAD Retail Price List/ Order Form

Account #: \_\_\_\_\_ Purchase Order No.: \_\_\_\_\_ Date: \_\_\_\_\_  
 Contact: \_\_\_\_\_ Mark For: \_\_\_\_\_

Bill To:	Ship To:
Address:	Address:
City/State/Zip:	
Phone:	City/State/Zip:
Email	Phone:

**US Configuration**

**Effective: 08.24.20 - Rev 3**

- Manatee
- Head support
- Leg belts
- Frame

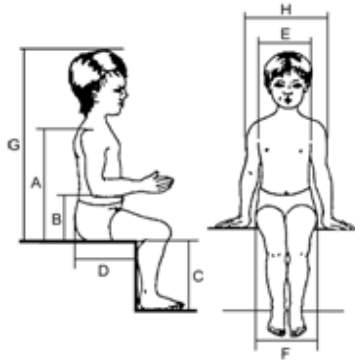

- A (Back Height) \_\_\_\_\_
- B (Arm Height) \_\_\_\_\_
- C (Lower Leg Length) \_\_\_\_\_
- D (Seat Depth) \_\_\_\_\_
- E (Chest Width) \_\_\_\_\_
- F (Seat Width) \_\_\_\_\_
- G (Height-Seat to Top of Head) \_\_\_\_\_
- H (Shoulder Width) \_\_\_\_\_
- Age \_\_\_\_\_
- Weight \_\_\_\_\_

**Measurements**

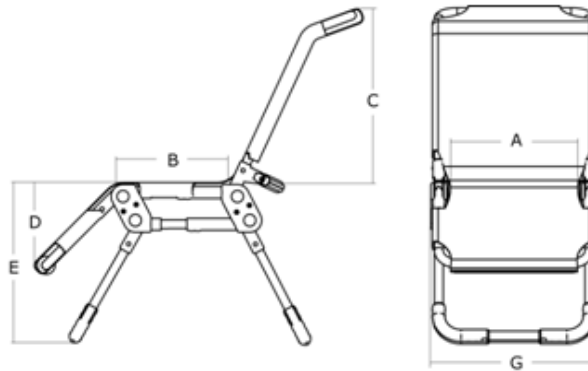

<b>Manatee</b>	<b>Size 0 Inches</b>	<b>Size 1 Inches</b>	<b>Size 2 Inches</b>	<b>Size 3 Inches</b>
Seat Width (A)	12¾"	12¾"	12¾"	15½"
Seat Depth (B)	8½ - 9¾"	11¼ - 14½"	15¼ - 18"	15½"-18¼"
Back Height (C)	16¾"	16¾"	22½"	25"
Lower Leg Length (D)	11"	11"	13¼"	13¼"
Seat Height (E)	5½ - 16¾"	5½ - 16¾"	5½ - 16¾"	5½-16¾"
Total Width (G)	16½"	16½"	16½"	19"
Length Folded	"40 - 43"	43 - 45¾"	53 - 55¾"	56-58¾"
Height Folded	5"	5"	5"	5"
Weight	12 lbs.	12 lbs.	13.25 lbs.	15½"
Max. Load	110 lbs.	110 lbs.	165 lbs.	165 lbs.

**Measurements**



<b>Frames</b>	<b>Shower Frame</b>	<b>Bath Tub Frame</b>
Width	23"	17"
Length	38¼"	28½ - 43¼"
Height	-	10½"
Height, Minimum	14¾"	-
Height, Minimum, with Chair	29¾"	-
Height, Middle	17"	-
Height, Middle, with Chair	32¾"	-
Height, Maximum	18¾"	-
Height, Maximum, with Chair	35¼"	-
Height, Folded	8"	-
Weight	17½ lbs.	4½ lbs.
Max. Load	165 lbs.	165 lbs.

**Manatee Standard Features**







- Manatee comes in 4 sizes; 0, 1, 2 or 3
- Head/Lateral Support
- Height Adjustable Foldable Frame
- Cover in Red or Blue Soft Nylon
- Belt for Waist/Hip
- HCPCS n/a for Manatee

<b>Description</b>	<b>Size</b>	<b>Part No.</b>	<b>CAD Price</b>
<b>Required, must select a color</b>			
<b>X = Color</b>			
<input type="checkbox"/> Blue = 5			
<input type="checkbox"/> Red = 4			
<input type="checkbox"/> Manatee, Blue *	0	882005	\$873
<input type="checkbox"/> Manatee	1	88201X	\$873
<input type="checkbox"/> Manatee	2	88202X	\$873
<input type="checkbox"/> Manatee	3	88203X	\$954
<i>* Size 0 is only available in Blue</i>			

<b>Frame</b>	<b>Description</b>	<b>Size</b>	<b>Part No.</b>	<b>CAD Price</b>
	<input type="checkbox"/> Basic Manatee Frame	One Size	882101	\$437
	<input type="checkbox"/> Rolling Shower Frame	One Size	882100	\$885
	<input type="checkbox"/> Wall Mount for Frame	One Size	882110	\$193
<b>Required, must select a color</b>				
<b>X = Color</b>				
<input type="checkbox"/> Blue = 5				
<input type="checkbox"/> Red = 4				
	<input type="checkbox"/> Net for Frame *	One Size	88210X	\$89
<i>*Custom order; Approx. lead time: 6-8 weeks</i>				

**IMPORTANT: No returns or exchanges accepted for this product**

Frame	Description	Size	Part No.	CAD Price
	<input type="checkbox"/> Tub Slider without Manatee w/ Casters (W: 50") *	1, 2	MC6000PED	\$4,072
	<input type="checkbox"/> Tub Slider without Manatee w/ Casters (W: 50")	3	MC6200PED	\$4,963
<i>*Custom order; Approx. lead time: 6-8 weeks. Non-returnable item</i>				

Accessories	Description	Measurements	Size	Part No.	CAD Price
<b>Required, must select a color</b>					
<b>X = Color</b>					
	<input type="checkbox"/> Blue = 5				
	<input type="checkbox"/> Red = 4				
	<input type="checkbox"/> Head/Lateral Support		0, 1, 2	88301X	\$137
	<input type="checkbox"/> Head/Lateral Support		3	88306X	\$137
	<input type="checkbox"/> Torso Belt		0, 1, 2	88302X	\$96
	<input type="checkbox"/> Torso Belt		3	88307X	\$96
	<input type="checkbox"/> Leg Straps		0, 1, 2	88305X	\$96
	<input type="checkbox"/> Leg Straps		3	88310X	\$121
	<input type="checkbox"/> Pommel		0, 1, 2	88304X	\$121
	<input type="checkbox"/> Pommel *		3	88309X	\$121
<i>*Pommel sz 3 in RED is a custom order; Approx. lead time: 6-8 weeks</i>					

Spare Parts	Description	Measurements	Size	Part No.	CAD Price
	<input type="checkbox"/> Belt for Waist/Hip		0, 1, 2	88303X	\$96
	<input type="checkbox"/> Belt for Waist/Hip		3	88308X	\$96
<b>Required, must select a color</b>					
<b>X = Color</b>					
	<input type="checkbox"/> Blue = 5				
	<input type="checkbox"/> Red = 4				
	<input type="checkbox"/> Cover *		0	882205	\$318
	<input type="checkbox"/> Cover		1	88221X	\$318
	<input type="checkbox"/> Cover		2	88222X	\$318
	<input type="checkbox"/> Cover		3	88223X	\$318
<i>* Size 0 is only available in Blue</i>					

**IMPORTANT: No returns or exchanges accepted for this product**

Prices in CAD & is subject to change without notice

**For Quotes and Orders please send completed Order Form to: [sales.us@etac.com](mailto:sales.us@etac.com) or fax: 1-800-760-0537**